

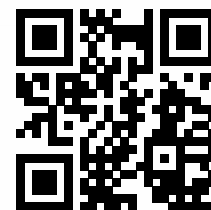





6 SERIES

<http://tiny.cc/6seriesEN>

 TIPPING LOAD 1200 kg	 ENGINE POWER 28 hp	 SPEED 15* km/h	 FLOW RATE 46 l/min	 LIFT HEIGHT 2,92 m
--	---	--	--	--

(*) 6.3S

Model	6.3+	6.3S
Engine	Yanmar 3TNV76	
Power (Iso Gross)	28 HP	
Fuel	Diesel	
Transmission	Hydrostatic	
Drive speed (max.)	11 km/h (6.8 mph)	15 km/h (9.3 mph)
Aux. hydraulics oil flow	46 l/min (12.2 GPM)	
Max. lifting height	2,92 m (115 in)	
Tipping load, max ⁽¹⁾	1200 kg (2646 lbs)	
Lifting capacity straight ⁽²⁾	960 kg (2116 lbs)	
Lifting capacity fully articulated ⁽³⁾	780 kg (1720 lbs)	
Breakout force / 50 cm	1400 kg (3086 lbs)	
Pushing force (c)	1690 kgf (1690 kp)	1160 kgf (1160 kp)
Specific ground pressure (w/standard tires)	1044 kg/m ² (214 lbs/sqft)	
Turning radius: inside/outside	905/2020 mm (35.6/79.5 in)	
Standard tires (Tractor profile)	23X8.50-12	
Weight	1430 kg (3153 lbs)	
Product Code	C961010	C961005
Price		

Tires size	Width (N)	Height (Q)
23X8.50-12	1070 mm (42 in)	2020 mm (79.5 in)
23X10.50-12	1130 mm (44.5 in)	2020 mm (79.5 in)
26X12.00-12	1300 mm (51.2 in)	2040 mm (80.3 in)
27X8.50-15	1070 mm (42 in)	2080 mm (81.9 in)
27X10.50-15	1150 mm (45.3 in)	2080 mm (81.9 in)

(1) Maximum load that can be lifted just off the ground when the machine is straight, with rear weights and boom not extended. Weight of attachment included.

(2) Machine straight, with rear weights and boom not extended. Weight of attachment is included. (80% of tipping load).

(3) Machine fully articulated, with rear weights and boom not extended. Weight of attachment is included.

6 SERIES - FEATURES AND OPTIONS

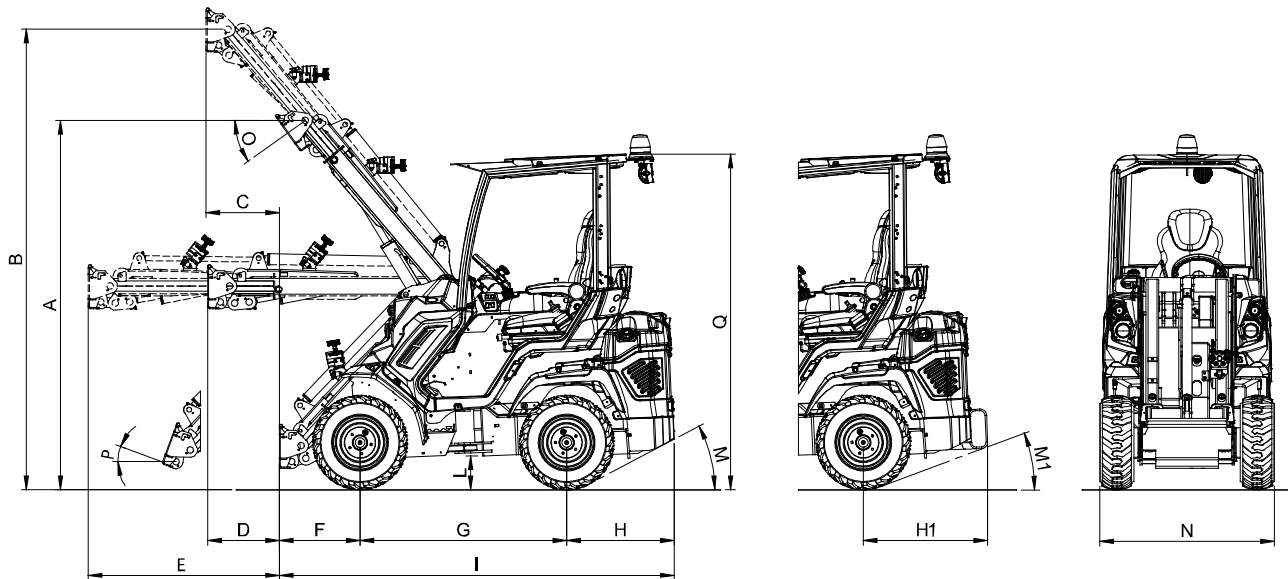

DIMENSIONS (mm / in)

A - Pivot point height (not extended boom)	2290 / 90.1	I - Machine length	2445 / 96.3
B - Pivot point height (extended boom)	2920 / 115	L - Ground clearance	210 / 8.3
C - Outreach with lifted boom (extended boom)	455 / 17.9	M - Angle of departure	28°
D - Outreach with orizontal boom (not extended)	445 / 17.5	M1 - Angle of departure with rear weights	24°
E - Outreach with orizontal boom (extended)	1185 / 46.6	N - Max width (with standard tires)	1070 / 42
F - Front length	500 / 19.7	O - Dump angle	36°
G - Wheelbase	1280 / 50.4	P - Rollback angle	29°
H - Rear length	665 / 26.2	Q - Height (with standard tires)	2020 / 79.5
H1 - Rear length with rear weights	770 / 30.3		

Features

- Hi-Flow system
- 4WD hydrostatic Direct Drive motors, proportional servo control
- DBS (Dynamic Block System)
- Self-levelling double-H telescopic boom
- 11-functions joystick
- Multi-disk parking brake
- Radial Piston high efficiency and heavy duty wheel motors
- Hydraulic oil cooler
- Hydraulic multiconnector
- ROPS-FOPS Level I
- LCD graphic display with programmed service (tachometer, hour meter, fuel gauge, maintenance light, light indicator and other 14 indicators)
- 2 front working light
- Ergonomic full adjustable suspension seat with armrests and safety belt

6 SERIES - FEATURES AND OPTIONS

Options	Code	Price
Attachment coupling plate for rear mounting	C880031	
Driver area cover	C880049	
Rear weights 180 kg/396 lbs (90kg/198lbs+90kg/198 lbs)	C880054	
4 wheel spacer 10 mm (0.4 in) (max. 1 pcs for wheel)	C880090	
Flat face coupling kit	C880221	
Plexiglass windscreen (smart cabin)	C883000	
Fully enclosed cab with sound insulation linen and mirrors	C883001	
Heating system	C883002	
High comfort heated seat	C883006	
Biodegradable oil	C883007	
Warning & Safety lights for road travel (with mirrors)	C883009	
Floating boom valve	C883011	
Rear hydraulic outlets - single	C883013	
Rear hydraulic outlets - double	C883014	
3 additional working LED light	C883018	
Left protection bar for operator	C883020	
Backup warning beeper	C883021	
Rear 12V electric socket	C883022	
Additional front hydraulic outlets	C883024	
Plexiglass right side (smart cabin)	C883034	
Plexiglass back window (smart cabin)	C883035	
Rear bull bar with side extensions	C883036	
Automatic locking plate	C883038	
Beacon light	C883039	
3 additional working halogen light	C883064	
Torque divider	C883600	
Grass tires 23x8.50-12, set of 4	C884006	
Tractor tires 23x10.50-12 ET-25, set of 4	C884007	
Grass tires 23x10.50-12 ET-25, set of 4	C884008	

6 SERIES - FEATURES AND OPTIONS

Options	Code	Price
Tractor tires 26x12.00-12 ET-50, set of 4	C884009	
Grass tires 26x12.00-12 ET-50, set of 4	C884010	
Skid tires 27x8.50-15, set of 4	C884011	
Skid tires 27x10.50-15, set of 4	C884012	
Wheel spacer 55 mm (2.2 in), set of 4	C885010	
Trailer coupling	C885014	
220 V engine block heater	C885250	
110 V engine block heater	C885255	
Snow chains for wheel	see page 60	

Machine packages		Code	Price
6.3+	ALL SEASON: Fully enclosed cab with sound insulation linen and mirrors + Heating system + Floating boom valve + Work light kit + Engine Block Heater	C961010/AS	
	COMFORT: High comfort heated seat + 3 additional working led lights + Floating boom valve	C961010/C	
6.3S	ALL SEASON: Fully enclosed cab with sound insulation linen and mirrors + Heating system + Floating boom valve + Work light kit + Engine Block Heater	C961005/AS	
	COMFORT: High comfort heated seat + 3 additional working led lights + Floating boom valve	C961005/C	